

# PG/M(AD) . . . Direct Tube Fast Connectors



**Material:** Nylon Plastic PA

**Protection Degree:** IP54

(with O-seal Circle And Fixed Installation: IP65)

**Ambient Temperature:** -40°C To 100°C

**Supply Color:** Grey ● RAL7012

Black ● RAL9005

Other Color, Please Inquiry

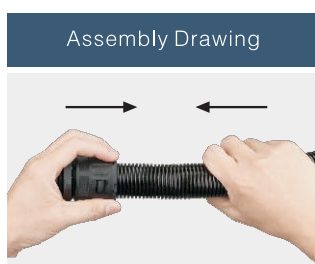

Assemble: Insert the flexible directly into the connector

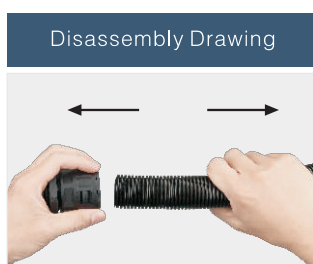

Disassemble: Tighten the connector to left, turn and pull the flexible tube to right



Thread	∅k mm AD	C1 mm	C2 mm	L mm	Number	
					GRAY RAL7012	BLACK RAL9005
PG7	10.0	12.5	10	32.5	P07D100	P07D101
PG9	13.0	15.2	10	32.5	P09D130	P09D131
PG11	15.8	18.6	10	32.5	P11D150	P11D151
PG13.5	18.2	20.4	10	32.5	P13D180	P13D181
PG16	21.2	22.5	12	43.5	P16D210	P16D211
PG21	28.5	28.3	12	46.0	P21D280	P21D281
PG29	34.5	37	12	48.5	P29D340	P29D341
PG36	42.5	47	11.5	50.5	P36D420	P36D421
PG48	54.5	59.3	14.5	54	P48D540	P48D541

M10×1.0	10.0	10	10	32.5	M10D100	M10D101
M12×1.5	13.0	12	10	32.5	M12D130	M12D131
M16×1.5	15.8	16	10	32.5	M16D150	M16D151
M20×1.5	21.2	20	12	43.5	M20D210	M20D211
M25×1.5	28.5	25	12	46.0	M25D280	M25D281
M32×1.5	34.5	32	12	48.0	M32D340	M32D341
M40×1.5	42.5	40	11.5	50.0	M40D420	M40D421
M63×1.5	54.5	63	14.5	54.0	M63D540	M63D541



# PG/M(AD) . . . Curving Tube Fast Connectors

CE cRUUS RoHS TÜV ISO9001

**Material:** Nylon Plastic PA  
**Protection Degree:** IP54  
 (with O-seal Circle And Fixed Installation: IP65)  
**Ambient Temperature:** -40°C To 100°C  
**Supply Color:** Grey ● RAL7012  
 Black ● RAL9005  
 Other Color, Please Inquiry

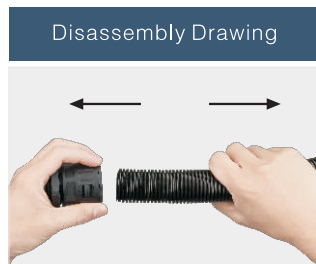
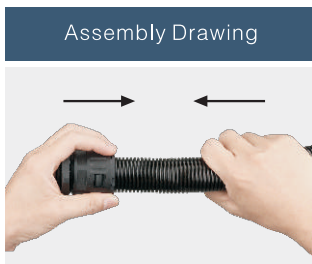

Assemble: Insert the flexible directly into the connector

Disassemble: Tighten the connector to left, turn and pull the flexible tube to right

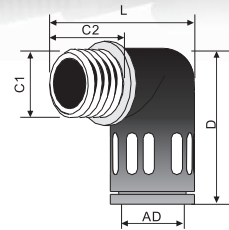

Thread	Øk mm AD	C1 mm	C2 mm	L mm	Number	
					GRAY RAL7012	BLACK RAL9005
PG7	10.0	12.5	10	32	P07D100Y	P07D101Y
PG9	13.0	15.2	10	34	P09D130Y	P09D131Y
PG11	15.8	18.6	10	37.5	P11D150Y	P11D151Y
PG13.5	18.5	20.4	11	44	P13D180Y	P13D181Y
PG16	21.5	22.5	12	47	P16D210Y	P16D211Y
PG21	28.5	28.3	12	55	P21D2800Y	P21D2801Y
PG29	34.5	37	12	63	P29D340Y	P29D341Y
PG36	42.5	47	12	70	P36D420Y	P36D421Y
PG48	54.5	59.3	14	83	P48D540Y	P48D541Y
<hr/>						
M12×1.5	13.0	12	12	36.5	M12D130Y	M12D131Y
M16×1.5	15.8	16	12	40.5	M16D150Y	M16D151Y
M20×1.5	21.2	20	13	49	M20D210Y	M20D211Y
M25×1.5	28.5	25	13	57	M25D280Y	M25D281Y
M32×1.5	34.5	32	15	67	M32D340Y	M32D341Y
M40×1.5	42.5	40	15	74	M40D420Y	M40D421Y
M50×1.5	54.5	50	16	86.5	M50D540Y	M50D541Y
M63×1.5	54.5	63	16	86.5	M63D540Y	M63D541Y

# PG/M . . . Direct Wing Buckled Fast Connectors



**Material:** Nylon Plastic PA  
**Protection Degree:** IP54  
 (with O-seal Circle And Fixed Installation: IP65)  
**Ambient Temperature:** -40°C To 100°C  
**Supply Color:** Grey ● RAL7012  
 Black ● RAL9005  
 Other Color, Please Inquiry

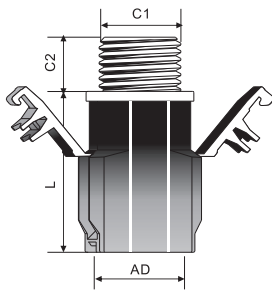

Thread	∅* mm AD	C1 mm	C2 mm	L mm	Number	
					GRAY RAL7012	BLACK RAL9005
PG7 (A)	10	12.5	10	22.5	P07D100Z	P07D101Z
PG7 (B)	11.6	12.5	10	22.5	P07D116Z	P07D117Z
PG9	13	15.2	10	22.5	P09D130Z	P09D131Z
PG11	15.8	18.6	10	25	P11D150Z	P11D151Z
PG13.5	18	20.4	11	29	P13D180Z	P13D181Z
PG16	21.2	22.5	12	31.5	P16D210Z	P16D211Z
PG21	28.5	28.3	12	34	P21D280Z	P21D281Z
PG29	34.5	37	12	36	P29D340Z	P29D341Z
PG36	42.5	47	13	38.5	P36D420Z	P36D421Z
PG48	54.5	59.3	15	39	P48D540Z	P48D541Z

M16×1.5	13	16	10	22.5	M16D130Z	M16D131Z
M20×1.5	18	20	11	29	M20D180Z	M20D181Z
M25×1.5	28.5	25	12	34	M25D280Z	M25D281Z
M32×1.5	34.5	32	12	36	M32D340Z	M32D341Z



# PG/M . . . Curving Wing Buckled Fast Connectors

CE cRUUS RoHS TÜV ISO9001

**Material:** Nylon Plastic PA

**Protection Degree:** IP54

(with O-seal Circle And Fixed Installation: IP65)

**Ambient Temperature:** -40°C To 100°C

**Supply Color:** Grey ● RAL7012

Black ● RAL9005

Other Color, Please Inquiry

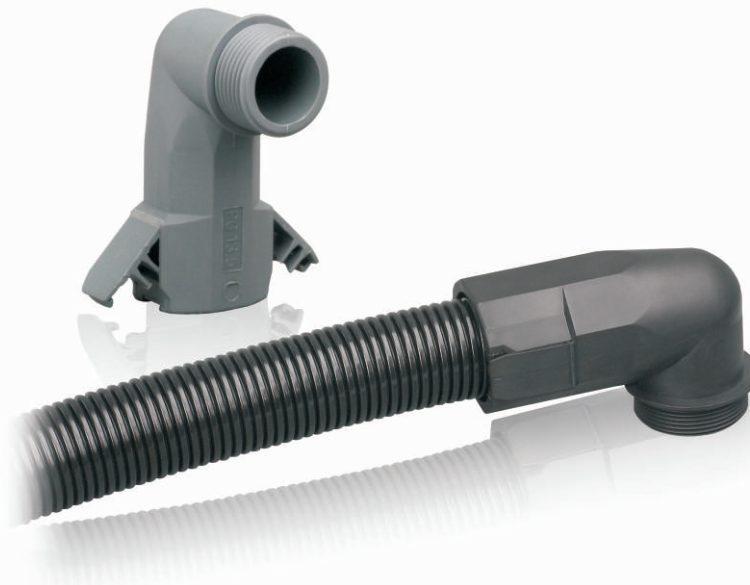
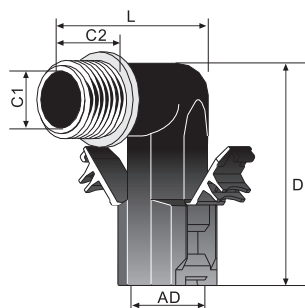

Thread	Ø mm AD	C1 mm	C2 mm	L mm	Number	
					GRAY RAL7012	BLACK RAL9005
PG7	10.0	12.5	10	32	P07D100ZY	P07D101ZY
PG9	13.0	15.2	10	34	P09D130ZY	P09D131ZY
PG11	15.8	18.6	10	37.5	P11D150ZY	P11D151ZY
PG13.5	18.5	20.4	11	44	P13D180ZY	P13D181ZY
PG16	21.5	22.5	12	47	P16D210ZY	P16D211ZY
PG21	28.5	28.3	12	55	P21D2800ZY	P21D2801ZY
PG29	34.5	37	12	63	P29D340ZY	P29D341ZY
PG36	42.5	47	12	70	P36D420ZY	P36D421ZY
PG48	54.5	59.3	14	83	P48D540ZY	P48D541ZY
M12×1.5	13.0	12	12	36.5	M12D130ZY	M12D131ZY
M16×1.5	15.8	16	12	40.5	M16D150ZY	M16D151ZY
M20×1.5	21.2	20	13	49	M20D210ZY	M20D211ZY
M25×1.5	28.5	25	13	57	M25D280ZY	M25D281ZY
M32×1.5	34.5	32	15	67	M32D340ZY	M32D341ZY
M40×1.5	42.5	40	15	74	M40D420ZY	M40D421ZY
M50×1.5	54.5	50	16	86.5	M50D540ZY	M50D541ZY
M63×1.5	54.5	63	16	86.5	M63D540ZY	M63D541ZY

# PG . . . Short Direct Fast Connectors



**Material:** Nylon Plastic PA  
**Hermetic Seal:** NBR  
**Protection Degree:** IP54  
 (with O-seal Circle And Fixed Installation: IP65)  
**Ambient Temperature:** -40°C To 100°C  
**Supply Color:** Grey ● RAL7035  
 Black ● RAL9005  
 Other Color, Please Inquiry

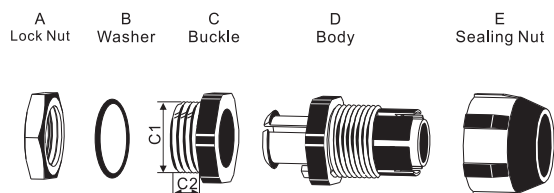

Thread	mm AD	C1 mm	C2 mm	L mm	Number	
					GRAY RAL7035	BLACK RAL9005
PG9	13	15	11	30	P0911150	P0911151
PG11	15.8	19	11	29.6	P1111190	P1111191
PG13.5	18.5	20	13.5	35	P1313200	P1313201
PG16	21.2	22	13.5	35.5	P1613220	P1613221
PG21	25/28.5	28	13.5	36.5	P2113280	P2113281
PG29	34.5	37	17	43.8	P2917370	P2917371



# PG . . . Round Fixed Buckled Connectors

CE cRUUS RoHS TÜV ISO9001

**Material:** Nylon Plastic PA

**Ambient Temperature:** -40°C To 100°C

**Supply Color:** Grey ● RAL7012

Black ● RAL9005

Other Color, Please Inquiry

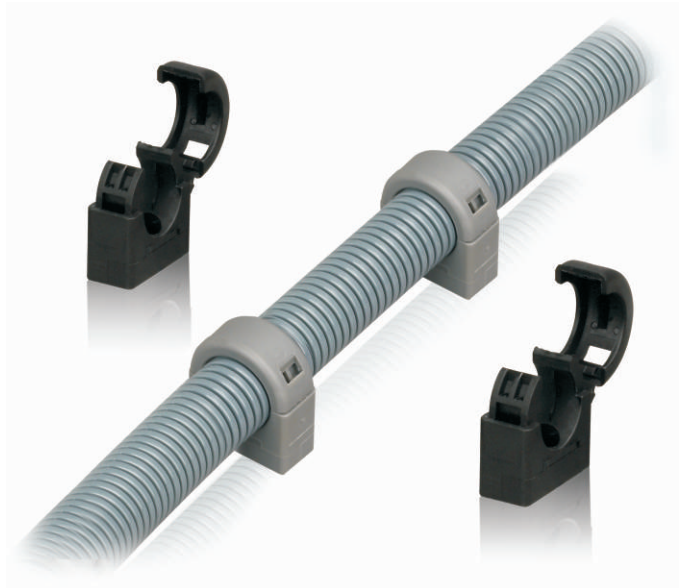
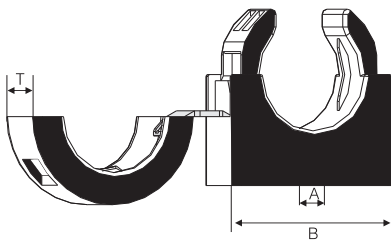

Thread	∅ <sub>k</sub> mm AD	B mm	H mm	T mm	A mm	Number	
						GRAY RAL7012	BLACK RAL9005
PG7	10	22.6	23.3	11.6	7	P07100K	P07101K
PG9	13	22.6	23.3	11.6	9	P09130K	P09131K
PG11	15.8	26.7	26.9	13.7	9	P11150K	P11151K
PG13.5	18.5	35	30	15	9	P13180K	P13181K
PG16	21.2	33.8	34.9	17.5	11.5	P16210K	P16211K
PG21	28.5	43.8	43.7	20.7	11.5	P21280K	P21281K
PG29	34.5	52.8	51.6	23.2	11.5	P29340K	P29341K
PG36	42.5	58.5	51	18	12	P36420K	P36421K
PG42	54.5	73	64	20	12	P42540K	P42541K



# AD . . . Wave Tubes



**Material:** Nylon Plastic PE、PP、PA  
**Ambient Temperature:** PE: -30°C To +100°C  
 PP: -30°C To +100°C  
 PA: -40°C To +160°C

**Color:** Black ●  
 Other Color, Please Inquiry

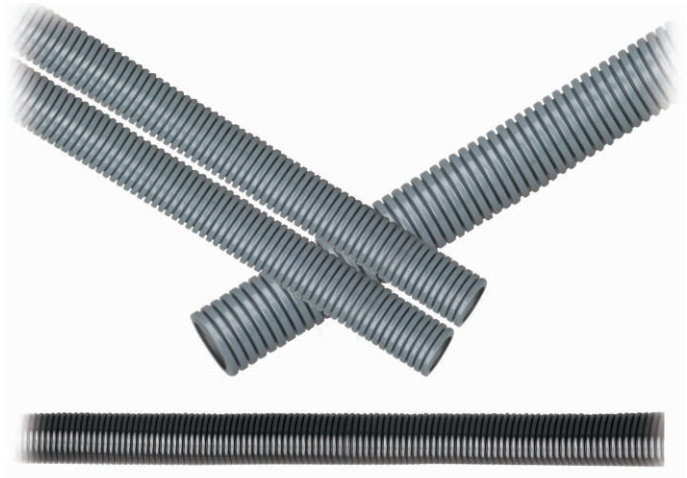
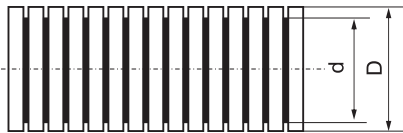

Type	∅ <sub>k</sub> mm AD	d×D mm	Curved Radius (mm)	Number
XDL-PE7	AD7	4.5×7.0	16	AD7PE
XDL-PE10	AD10	7.0×10	16	AD10PE
XDL-PE13	AD13	10×13	20	AD13PE
XDL-PE15.8	AD15.8	12×15.8	30	AD15.8PE
XDL-PE18.5	AD18.5	14.3×18.5	40	AD18.5PE
XDL-PE21.2	AD21.2	17×21.2	45	AD21.2PE
XDL-PE25	AD25	21×25	45	AD25PE
XDL-PE28.5	AD28.5	23×28.5	50	AD28.5PE
XDL-PE34.5	AD34.5	29×34.5	60	AD34.5PE
XDL-PE42.5	AD42.5	36×42.5	70	AD42.5PE
XDL-PE54.5	AD54.5	48×54.5	90	AD54.5PE
<hr/>				
XDL-PP7	AD7	4.5×7.0	16	AD7PP
XDL-PP10	AD10	7.0×10	16	AD10PP
XDL-PP11	AD11	8.5×11	16	AD11PP
XDL-PP13	AD13	10×13	20	AD13PP
XDL-PP15.8	AD15.8	12×15.8	30	AD15.8PP
XDL-PP18.5	AD18.5	14.3×18.5	40	AD18.5PP
XDL-PP21.2	AD21.2	17×21.2	45	AD21.2PP
XDL-PP25	AD25	21×25	45	AD25PP
XDL-PP28.5	AD28.5	23×28.5	50	AD28.5PP
XDL-PP34.5	AD34.5	29×34.5	60	AD34.5PP
XDL-PP42.5	AD42.5	36×42.5	70	AD42.5PP
XDL-PP54.5	AD54.5	48×54.5	90	AD54.5PP
<hr/>				
XDL-PA10	AD10	7.0×10	16	AD10PA
XDL-PA13	AD13	10×13	20	AD13PA
XDL-PA15.8	AD15.8	12×15.8	30	AD15.8PA
XDL-PA18.5	AD18.5	14.3×18.5	40	AD18.5PA
XDL-PA21.2	AD21.2	17×21.2	45	AD21.2PA
XDL-PA25	AD25	21×25	45	AD25PA
XDL-PA28.5	AD28.5	23×28.5	50	AD28.5PA
XDL-PA34.5	AD34.5	29×34.5	60	AD34.5PA
XDL-PA42.5	AD42.5	36×42.5	70	AD42.5PA
XDL-PA54.5	AD54.5	48×54.5	90	AD54.5PA